

SEM1610 USER GUIDE

DIN RAIL MOUNTED TRANSMITTER
 UNIVERSAL INPUT
 TWO WIRE (4 to 20) mA OUTPUT

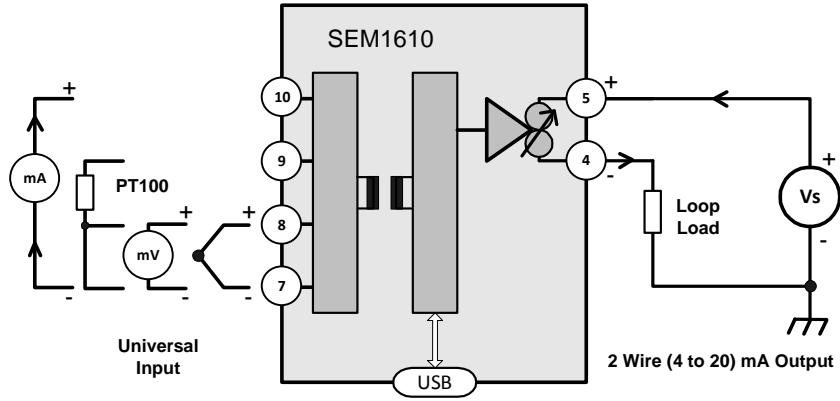

Important - Please read this document before any installing.

Every effort has been taken to ensure the accuracy of this document, however we do not accept responsibility for damage, injury, loss or expense resulting from errors and omissions, and we reserve the right of amendment without notice.



IMPORTANT - CE & SAFETY REQUIREMENTS

Product must be DIN rail mounted, inside a suitable enclosure providing environmental protection to IP65 or greater.

To maintain CE EMC requirements, input wires must be less than 30 metres.

The product contains no serviceable parts, or internal adjustments. no attempt must be made to repair this product. Faulty units must be returned to supplier for repair.

This product must be installed by a qualified person. All electrical wiring must be carried out in accordance with the appropriate regulations for the place of installation.

Before attempting any electrical connection work, please ensure all supplies are switched off.

ABSOLUTE MAXIMUM CONDITIONS (To exceed may cause damage to the unit):-

Supply Voltage	± 30 V dc (Protected for over voltage and reverse connection)
Current with over voltage	± 200 mA
Input Voltage	± 5 V between any terminals
Input Current	± 100 mA between terminals 7 & 10
Ambient	Temperature (-30 to 75) °C Humidity (10 to 95) % RH (Non condensing)

PRODUCT SPECIFICATION

Please refer to the product data sheet for full specification, available to download at www.status.co.uk.

RECEIVE AND UNPACKING

Please inspect the packaging and instrument thoroughly for any signs of transit damage. If the instrument has been damaged, please notify your supplier immediately.

CONFIGURATION



IMPORTANT The SEM1610 can be configured whilst connected and powered, but a portable battery powered computer must be used to avoid the effects of ground loops.

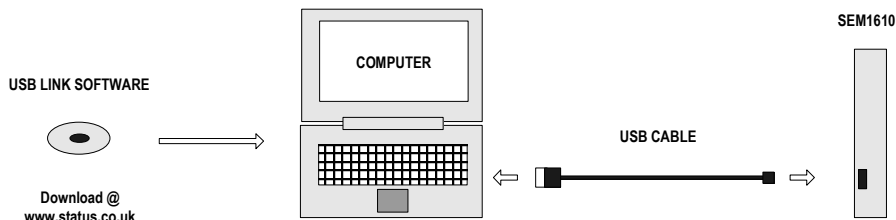

The following parameter can be configured by simply entering as prompted by the software package.

- Input type (K,J,E,N,T,R,S,mV,PT100,mA)
- Low range
- High range
- Units (°C, °F, mV, mA)
- Burnout (direction of output current on sensor burnout)
- User Adjust (option to lock out front panel adjust function)

Factory default:

Input type	= P
Units	= °C
High Range	= 100
Low Range	= 0
Burnout	= UPSCALE
User Adjust	= ON

MECHANICAL INSTALLATION

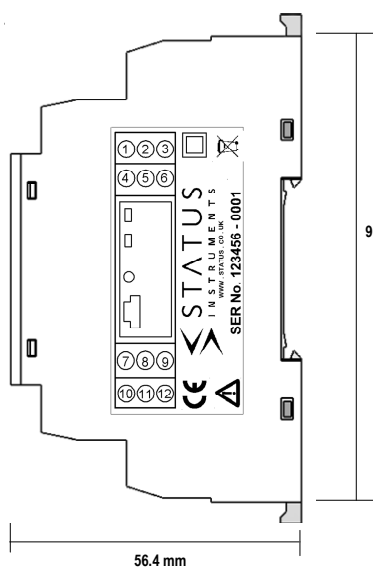

MOUNTING

① Screw driver



② EN50022 DIN RAIL

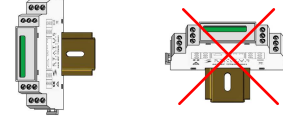

90 mm



+ 70 °C Max

- 20 °C Min

SEM1610 Enclosure

Style DIN 43880 (1 module width)
 Material Polyamide 6.6 self extinguishing
 Terminals Screw terminal
 Cable 2.5 mm Max
 Colour Grey

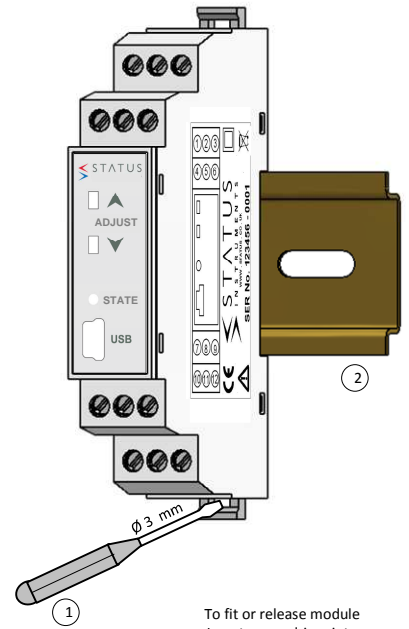

To fit or release module
 Insert screw driver into
 slot and lever latch
 away from body

ELECTRICAL INSTALLATION

Screened Cable



Twisted Pair Cable



TC Compensation Cable
 Screened



Screw Driver

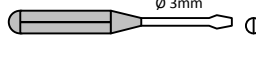

TURN OFF SUPPLY BEFORE WORKING ON ANY ELECTRICAL CONNECTION

UNIVERSAL INPUT CONNECTION

For cable length < 3 Metres no screen or twist pair required. Thermocouple inputs must use correct compensation cable. PT100 inputs all three wire must be equal length (resistance). Use recommended types for cable length (3 to 30) metres.

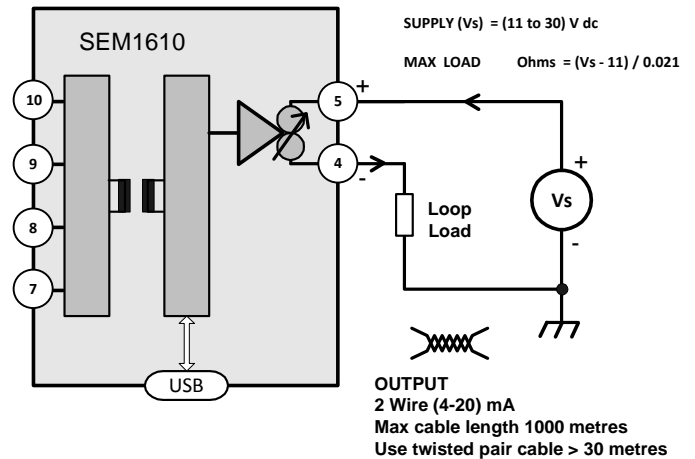
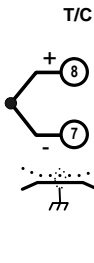
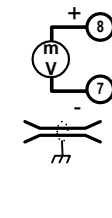
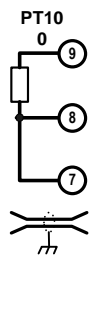
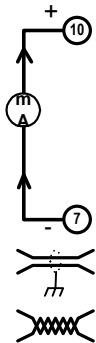

USER ADJUST

Screw Driver

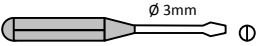

Digital mA meter



Power supply (24V dc)

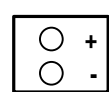

Input Simulator

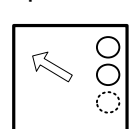

or sensor

User adjust function allows manual adjustment of the output current, this is useful for minor calibration adjustment or trimming out any sensor error, ± 5% of range adjustment is available at both offset and span. Raise and lower buttons are provided on the front panel, of the transmitter, accessed using a 3 mm flat blade screw driver. Insert the screw driver into the appropriate slot to operate the button. The button has a click action.

The transmitter will automatically detect the correct adjust point (offset or span) based on the output current drive. Offset will be adjusted when the current is between (3.8 to 6) mA, span when the current is between (18 to 22) mA. No trim action occurs at any other current.

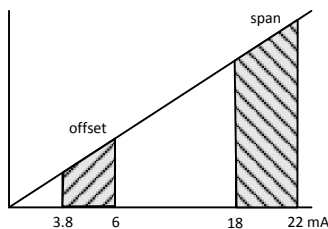

METHOD

1.0 Connect transmitter to a suitable input simulator or sensor. Connect output to a 24V dc supply, connecting a digital mA current meter in series with the output. Turn supply on, set input to either offset or span calibration point.

2.0 Enter adjust menu by pressing "raise" button for > two seconds. When the adjust menu is open the range LED will flash :-

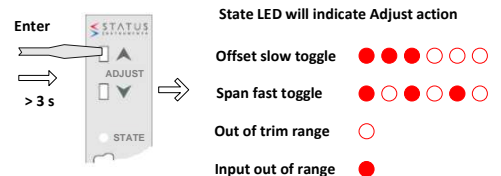

3.0 Adjust output current by pressing either the raise or lower button, single click to step advance, or press continuously to auto advance.

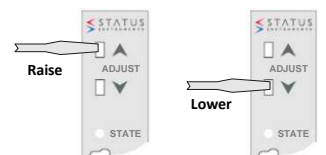

4.0 Once adjust is complete allow 30 seconds with no button press, the transmitter will time out and return to normal operation.

