

SEM1750 USER INSTRUCTIONS

Important - Please read this document before installing.

Every effort has been taken to ensure the accuracy of this document; however, we do not accept responsibility for damage, injury, loss or expense resulting from errors and omissions, and we reserve the right of amendment without notice.

IMPORTANT – CE, UKCA & SAFETY REQUIREMENTS

Product must be DIN rail mounted, inside a suitable enclosure providing environmental protection to IP65 or greater.

To maintain CE EMC requirements, input and supply wires must be less than 30 metres.

The product contains no serviceable parts, or internal adjustments. No attempt must be made to repair this product. Faulty units must be returned to supplier for repair. Before attempting any electrical connection work, please ensure all supplies are switched off.

ABSOLUTE MAXIMUM CONDITIONS (To exceed may cause damage to the unit).	
Working voltage terminals Inputs	± 75 V dc @ 75 mA dc
Working voltage terminals Outputs	± 30 V dc @ 50 mA dc
Supply voltage	(20 to 240) Vac 50/60 Hz or (20 to 240) Vdc, 3 W
Input (SELV)	±50 Vdc or ±50 mAdc
Output (SELV)	Current (0 to 20) mA, Voltage (0 to 10) V
Ambient	Temperature (-20 to 70) °C Approvals EN61010_1, EN61326
External supply	1 A anti-surge fuse recommended
Isolation supply to input/output	4250 V
Any input to output	3750 V
Output to output, input to input	3750 V



Important – Read this document before installing.

1-DESCRIPTION.

SEM1750 is a dual channel signal conditioner designed to accept mA or voltage inputs and provide isolated, industrial process output signals in mA or Volts. Each output channel may be linked to either an input signal or to a maths function of both input signals. This powerful feature allows the device to operate in several different modes. The output signal can also be adjusted over the full working ranges (0 to 20) mA or (0 to 10) V, to provide common or custom process signals, examples (4 to 20) mA, (0 to 1) mA, (1 to 5) V. The SEM1750 is configured using the free software that allows the user to configure the device without requiring calibration equipment. Maths functions on each channel can be set up using the software as well as a 22-segment profile tool. Input/output simulation tools for diagnostic purposes are also available.

2-RECEIVING AND UNPACKING.

Please inspect the packaging and instrument thoroughly for any signs of transit damage. If the instrument has been damaged, please notify your supplier immediately.

3-SPECIFICATION.

Refer to data sheet for full specification. Download at www.status.co.uk

Factory defaults	Basic mode, dual channel operation, 420 ms update, (Ch1, Ch2) = (4 to 20) mA input, (4 to 20) mA output
------------------	---

4-INSTALLATION AND WIRING.

Important safety requirements

This equipment is suitable for environment Installation category II pollution degree 1 and is classed as "PERMANENTLY CONNECTED EQUIPMENT". The equipment is intended for industrial and commercial application only and not suitable for domestic or medical use.

The equipment must be mounted inside an enclosure that provides protection >= IP65. In NORMAL USE, the equipment will only be accessed for maintenance by qualified personnel. Please ensure the equipment is mounted vertically with terminals (101 to 204) at the bottom. This will provide maximum ventilation. This equipment may generate heat: ensure the enclosure size is adequate to dissipate heat. Be sure to consider any other equipment inside the enclosure.

The equipment surfaces may be cleaned with a damp cloth. Use a mild detergent/water. Ensure the supply is off before cleaning and on completion of cleaning the equipment is completely dry before the supply is turned back ON.

This equipment must be installed by a qualified person. All electrical wiring must be carried out in accordance with the appropriate regulations for the place of installation. DC supply must be derived from a local supply and not a distribution system.

Supply (20 to 240) Vac 50/60 Hz (20 to 240) Vdc. If supply is a HAZARDOUS VOLTAGE, a supply isolation switch must be installed close to the equipment with the "OFF" position clearly marked. Also, the supply must be fused with a suitable 1 A (T) fuse (circuit breaker) installed close to the equipment.

USB configuration can be performed without the supply being connected. For safety reasons, use 24 Vdc for a functional test of the unit prior to fixed installation. The following operations should only be carried out on a disconnected device and under ESD safe conditions: General mounting, connection and disconnection of wires.

4.1-MECHANICAL.

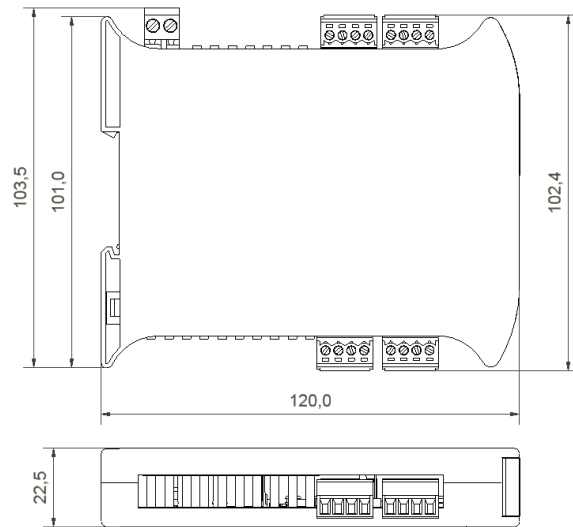

The equipment must be mounted on a DIN rail style DIN EN50022 inside a plastic or metal enclosure with a protection level >= IP65. All wiring must be secured. Maximum cable sizes 2.5 mm. Connection two-part screw terminals.

4.2-ELECTRICAL CONNECTIONS

For wiring connections, refer to the side label on the SEM1750 and this document. For channel one use pins 101 to 108, for channel two use pins 201 to 208

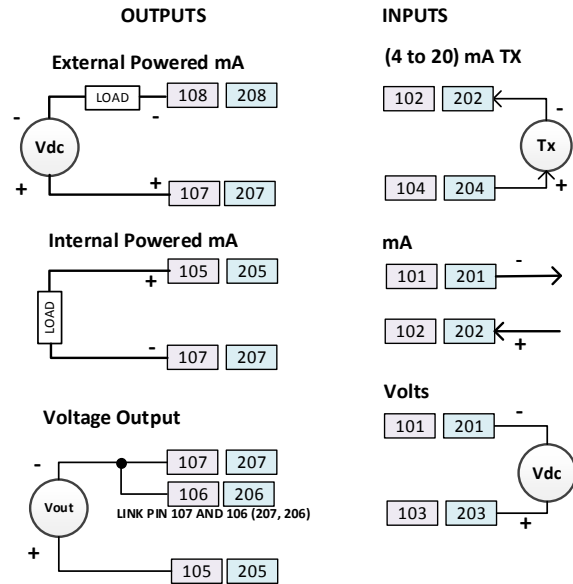

SUPPLY (20 to 240) V dc 50/60 Hz ^{S2+}
(20 to 240) V dc ^{S1-}
Max Power 3W

Input connections for cable length >3 metres: use screen or twisted pair cables. Max cable run 30 metres.

Output connections for cable length >3 metres: use screen or twisted pair cables. For current outputs max cable run 1000 metres, Voltage output 30 metres.

Supply maximum cable run 30 metres. As stated in the IMPORTANT SAFETY REQUIREMENTS the supply must be fused with a 1A (T) fuse and provision provided to isolate the circuit when hazardous voltages are being switched.

LED front panel indication.

Channel 1 and channel 2 LEDs show green for in range input condition. Channel 1 and channel 2 LEDs show red for out of range input condition.

5-USER CONFIGURATION.



Read the Important safety requirements

PC CONFIGURATION

During configuration the equipment takes its power from the USB port, therefore no power connection is required. The equipment can be configured whilst powered but the computer used must be isolated from the supply earth to avoid grounded earth loop effects.

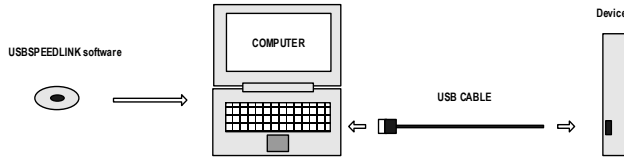

Configuration steps using USBSpeedLink	
Download install and run USBSpeedLink	
Connect device to PC using an A to mini B USB lead	
Upload device set-up into the configuration software, "Basic" and "Advanced" options are available for configuring the device	
Adjust settings as required	
Send new configuration to the device	

USBSpeedLink software configuration screen for SEM1750

Note: When the device is correctly connected, the "Send" and "Receive" menu buttons will turn black and the "data" section of the screen will open on the right.

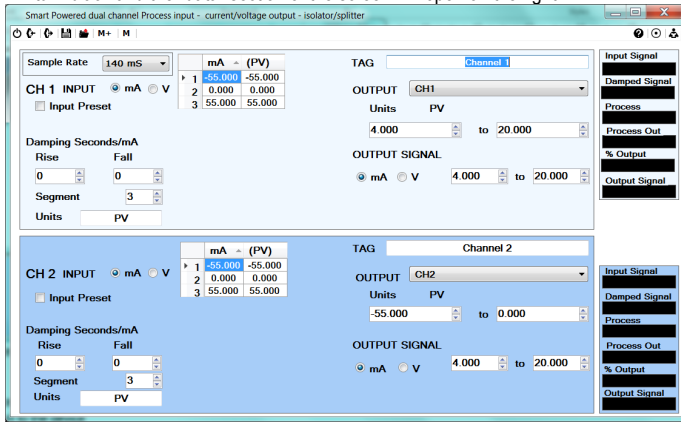

Advanced configuration screen shown

Sample Rate

Select: (420, 140, 70) ms update rate. A faster response time will reduce accuracy.

Input (Ch1 and Ch2)

Select: input type mA or V

Input Pre-set (Ch1 and Ch2)

This will open a box to enter a value for the input (mA or V) that the device will take as its input condition. The actual input will be ignored while this input pre-set is selected. The device will respond accordingly to the pre-set input value on its output.

Damping seconds mA/V (Ch1 and Ch2)

User-adjustable damping of the analogue output is provided for both rising and falling signals. The adjustable range is (0 to 3600) s for a 1 mA or 1 V swing. Example: If the damping value is set at 2 s (per mA) then a 5 mA change on the input will take 10 s on the output to respond fully.

Segments (Ch1 and Ch2)

Controls the number of mA/V input to output points

This will normally be used to range the electrical input mA/V to the relevant engineering unit °C, bar, l/min for example.

For a straight-line alignment only 3 points need to be used.

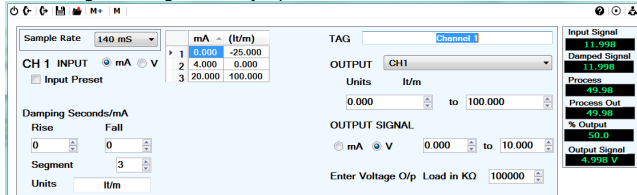

More segments can be used if required to control out of limit conditions.

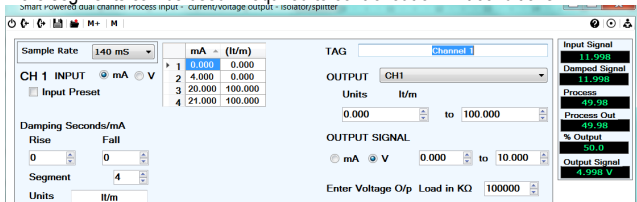

Up to 22 user-segments can be used to create a user curve or non-linear relationship table, for example to represent the volume in a non-linear tank. This can also be used to correct or calibrate an input sensor.

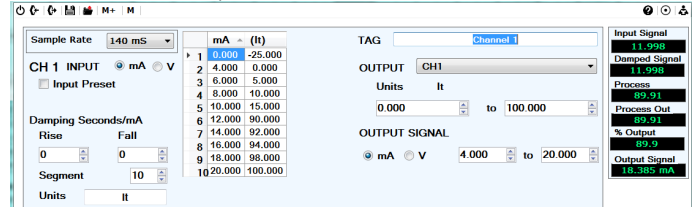

Units (Ch1 and Ch2)

This allows the user to enter the engineering units for the input to output relationship

Tag (Ch1 and Ch2)

This allows the user to enter text description that is saved to the device.

OUTPUT (Ch1 and Ch2)

A list of output options is available from a drop-down box.

The most common selection will be to match channel input to channel output, however, both output channels can have the same input selected, making the device into a signal splitter

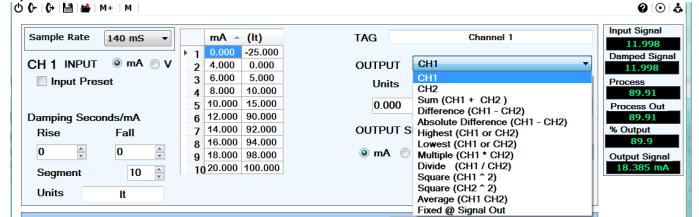

Other options are available including maths functions and a fixed output option that may be used as a diagnostics tool.

OUTPUT Units (Ch1 and Ch2)

Select the range in engineering units that is to be scaled to the analogue output signal.

OUTPUT SIGNAL (Ch1 and Ch2)

Select mA or V and the output range to be scaled to the engineering range. This can be any value within the physical capability of the device.

For a voltage output, the output load value, if known, can also be entered.

OUTPUT SIGNAL (Ch1 and Ch2)

Select mA or V and the output range to be scaled to the engineering range. This can be any value within the physical capability of the device.

For a voltage output, the output load value, if known, can also be entered.

Menu Options

The configuration can be saved to PC file for back up and re-use as required.

The USBSpeedLink software will allow live readings to be taken from the device showing input and output conditions.

For diagnostic use, the device can save live readings to a text file on the PC.



USBSpeedLink configuration software is available online at www.status.co.uk

This guide is also available online at www.status.co.uk

Status Instruments Ltd, Status Business Park, Gannaway Lane, Tewkesbury, Gloucestershire, UK, GL20 8FD,

Web Page: www.status.co.uk

Email: sales@status.co.uk

Technical Support: support@status.co.uk

Tel: +44 (0) 1684 296818, Fax: +44 (0) 1684 293746